

Moduli bancone dritti – Moduli bancone curvi 60° – Moduli bancone raccordo 90°/Straight counter units – 60° curved counter units – 90° counter corner units

D 35 7/16" x H 29 9/16"

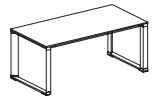

901.TS.48.18_W 70 7/8"
901.TS.48.20_W 78 6/8"

D 35 7/16" x H 29 9/16"

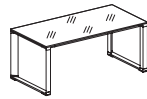

901.TV.17.18_W 70 7/8"
901.TV.17.20_W 78 6/8"

V

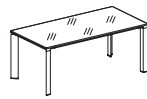

901.TV.01.18_W 70 7/8"
901.TV.01.20_W 78 6/8"

D 35 7/16" x H 29 9/16"

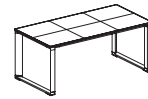

901.TS.48.18_W 70 7/8"
901.TS.48.20_W 78 6/8"

C

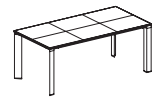

901.TS.03.18_W 70 7/8"
901.TS.03.20_W 78 6/8"

D 35 7/16" x H 29 5/16"



901.TV.17.18_W 70 7/8"
901.TV.17.20_W 78 6/8"

G



901.TV.01.18_W 70 7/8"
901.TV.01.20_W 78 6/8"

W 63" D 31 1/2" x H 29 9/16"



901.TS.02.16_

W 63" D 31 1/2" x H 29 5/16"

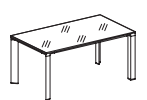

901.TV.15.16_

W 63" D 31 1/2" x H 29 9/16"



901.TS.02.16_

Tavoli dattilo/Typing tables

W 47 1/4" D 23 5/8" x H 29 9/16"

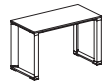

901.TS.50.12_



901.TS.44.12_

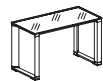

901.TV.19.12_



901.TV.16.12_

W 47 1/4" D 23 5/8" x H 29 9/16"



901.TS.50.12_

C



901.TS.44.12_

W 47 1/4" D 23 5/8" x H 29 9/16"



901.TV.19.12_

G



901.TV.16.12_

Tavoli riunione/Meeting tables

Ø 39 3/8" x H 29 5/16"

V G HA

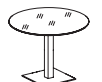

901.TV.14.10_

V H

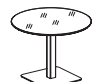

901.TV.15.10_

Ø 39 3/8" x H 29 9/16"

G G HA



901.TV.14.10_

G G H



901.TV.15.10_

W 39 3/8" D 39 3/8" x H 29 9/16"



901.TR.42.10_

W 39 3/8" D 39 3/8" x H 29 5/16"

V



901.TV.77.10_

W 39 3/8" D 39 3/8" x H 29 9/16"

C



901.TR.42.10_

W 63" D 63" x H 29 9/16"

G



901.TV.77.10_

W 63" D 63" x H 29 9/16"

G



901.TR.43.16_

W 63" D 63" x H 29 5/16"

V

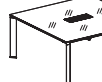

901.TV.38.16_

W 63" D 63" x H 29 9/16"

C

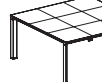

901.TR.43.16_

G



901.TR.51.16_

C G H



901.TR.51.16_

W 94 1/2" D 47 1/4" x H 29 9/16"



901.TR.41.24_

W 94 1/2" D 47 1/4" x H 29 5/16"

V



901.TV.36.24_

W 94 1/2" D 47 1/4" x H 29 9/16"

C

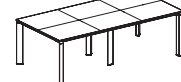

901.TR.41.24_

W 94 1/2" D 47 1/4" x H 29 5/16"

G



901.TV.36.24_

Allunghi per tavoli scrivania L 160 – 180/Extension tables for desks W 63" – 70 7/8"

W 47 1/4" D 23 5/8" x H 29 9/16"

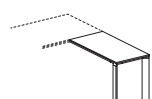

901.TD.31.12_ Dx/R
901.TD.33.12_ Sx/L

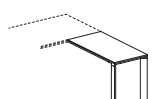

901.TD.30.12_ Dx/R
901.TD.32.12_ Sx/L

W 47 1/4" D 23 5/8" x H 29 5/16"

V

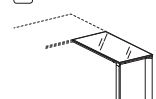

901.TV.22.12_ Dx/R
901.TV.24.12_ Sx/L

V

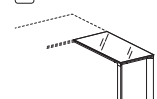

901.TV.21.12_ Dx/R
901.TV.23.12_ Sx/L

W 47 1/4" D 23 5/8" x H 29 9/16"

G

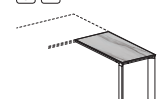

901.TV.22.12_ Dx/R
901.TV.24.12_ Sx/L

G

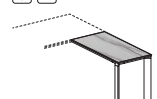

901.TV.21.12_ Dx/R
901.TV.23.12_ Sx/L

W 47 1/4" D 23 5/8" x H 29 9/16"

C

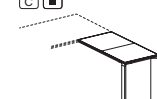

901.TD.31.12_ Dx/R
901.TD.33.12_ Sx/L

C

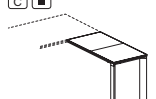

901.TD.30.12_ Dx/R
901.TD.32.12_ Sx/L

Allunghi per tavoli scrivania L 200/Extension tables for desks W 78 6/8"

W 47 1/4" D 23 5/8" x H 29 9/16"

*

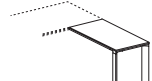

901.TD.27.12_

*

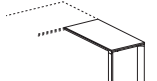

901.TD.26.12_

W 47 1/4" D 23 5/8" x H 29 5/16"

V *

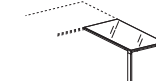

901.TV.20.12_

V *

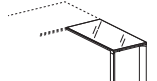

901.TV.04.12_

W 47 1/4" D 23 5/8" x H 29 9/16"

G *

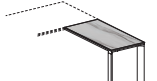

901.TV.20.12_

G *

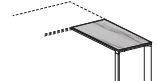

901.TV.04.12_

W 47 1/4" D 23 5/8" x H 29 9/16"

C *

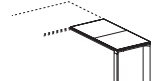

901.TD.27.12_

C *

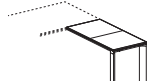

901.TD.26.12_

Tavoli riunione componibili con gambe centrali rientrate/Modular meeting tables with central recessed legs

W 126" D 31 1/2" x H 29 9/16"

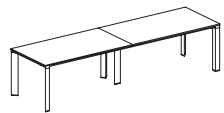

901.TR.55.32_

□ ■

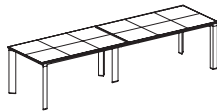

901.TR.55.32_

D 35 7/16" x H 29 9/16"

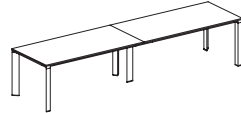

901.TR.55.36_W 141 3/4"
901.TR.55.40_W 157 1/2"

□ ■

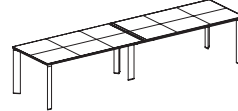

901.TR.55.36_W 141 3/4"
901.TR.55.40_W 157 1/2"

W 126" D 63" x H 29 9/16"



901.TR.32.32_

W 126" D 63" x H 29 9/16"

∞

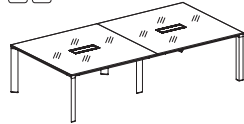

901.TV.47.32_

□ ■

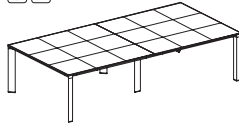

901.TR.32.32_

∞

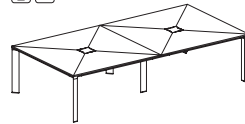

901.TR.52.32_

□ ■ ∞

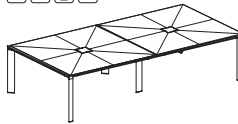

901.TR.52.32_

W 189" D 63" x H 29 9/16"

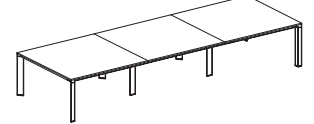

901.TR.32.48_

W 189" D 63" x H 29 9/16"

∞

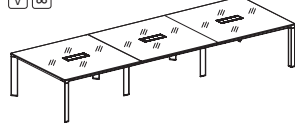

901.TV.47.48_

□ ■

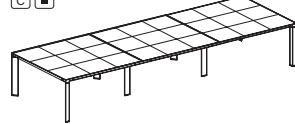

901.TR.32.48_

∞

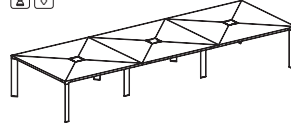

901.TR.52.48_

□ ■ ∞

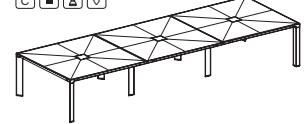

901.TR.52.48_

Elementi per tavoli riunione componibili con gambe centrali rientrate/Modular elements for compound meeting tables with central recessed legs

W 63" D 31 1/2" x H 29 9/16"



901.TR.55.16_

□ ■

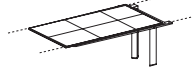

901.TR.55.16_

D 35 7/16" x H 29 9/16"



901.TR.55.18_W 70 7/8"
901.TR.55.20_W 78 5/8"

□ ■

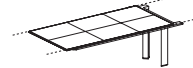

901.TR.55.18_W 70 7/8"
901.TR.55.20_W 78 5/8"

W 63" D 63" x H 29 9/16"

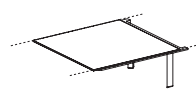

901.TR.32.16_

□ ■

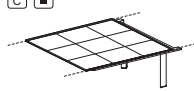

901.TR.32.16_

∞

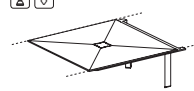

901.TR.52.16_

□ ■ ∞

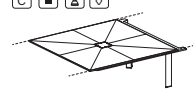

901.TR.52.16_

W 63" D 63" x H 29 5/16"

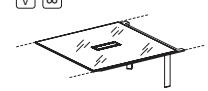

901.TV.47.16_

Tavoli per integrazione con mobili di servizio/Desks for integration with service units

D 35 7/16" x H 29 9/16"

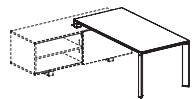

901.TI.15.18_W 70 7/8"
901.TI.15.20_W 78 6/8"

D 35 7/16" x H 29 5/16"

∞

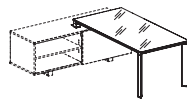

901.TV.11.18_W 70 7/8"
901.TV.11.20_W 78 6/8"

D 35 7/16" x H 29 9/16"

□ ■

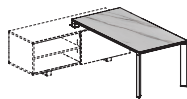

901.TV.11.18_W 70 7/8"
901.TV.11.20_W 78 6/8"

D 35 7/16" x H 29 9/16"

□ ■

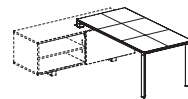

901.TI.15.18_W 70 7/8"
901.TI.15.20_W 78 6/8"

W 63" D 63" x H 29 9/16"

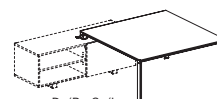

901.TI.16.16_Dx/R
901.TI.17.16_Sx/L

W 63" D 63" x H 29 5/16"

∞ □ ■

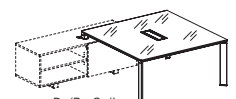

901.TV.22.16_Dx/R
901.TV.23.16_Sx/L

W 63" D 63" x H 29 9/16"

□ ■

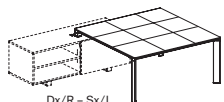

901.TI.16.16_Dx/R
901.TI.17.16_Sx/L

W 63" D 63" x H 29 9/16"

∞ □

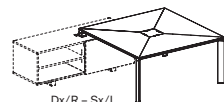

901.TI.18.16_Dx/R
901.TI.19.16_Sx/L

W 63" D 63" x H 29 9/16"

∞ □ ■ ∞

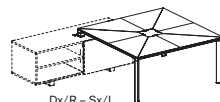

901.TI.18.16_Dx/R
901.TI.19.16_Sx/L

Note:

1 Le finiture gres e cuoio non sono in pronta consegna. Per la disponibilità contattare l'ufficio commerciale/Porcelain stoneware and leather finishes are not in prompt delivery. Please contact the commercial department to check availability;

2 Le dimensioni sono espresse in pollici - consultare il listino prezzi per le caratteristiche tecniche, i codici degli articoli e delle finiture/Dimensions are stated in inch - for technical characteristics, article code numbers and finishing see price list;

■ Prodotti non in pronta consegna. Per la disponibilità contattare l'ufficio commerciale/Items not in prompt delivery. Please contact the commercial department to check availability;

∞ Fino ad esaurimento/Until exhaustion;

∞ Per eventuali giacenze a magazzino delle precedenti versioni senza top-access, contattare l'ufficio commerciale/To check stock availabilities of table tops without top-access, please contact our commercial department;

HA Gambone in alluminio anodizzato / Metal column made in "Anodized" aluminium;

H Gambone verniciato a polveri in bianco, alluminio o antracite / Metal column electrostatic painted in white, aluminum or anthracite;

∞ Vetro/Glass; □ Cuoio/Leather; □ Gres/Gres;

✳ Allunghi montabili anche in posizione centrale sui tavoli scrivania L 160 - 180 - 200 (vedere listino)/Extensions suitable also for central position on desks W 63" - 70 7/8" - 78 6/8" (see price list);

∞ Tavoli scrivania con piani composti/Desks with compound worktops.

Esempi posizionamento tavoli riunione P 90 con mobili di servizio/Examples of meeting tables D 35 7/16" positioning with service units

W 70 7/8" x H 29 9/16"

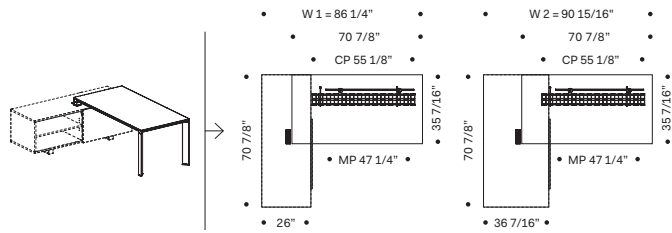

W 78 6/8" x H 29 9/16"

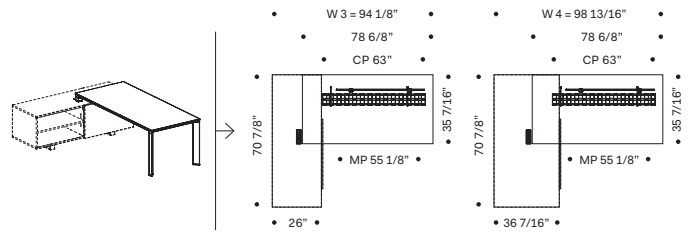

Esempi posizionamento tavoli riunione L 160 con mobili di servizio/Examples of meeting tables W 63" positioning with service units

D 63" x H 29 9/16"

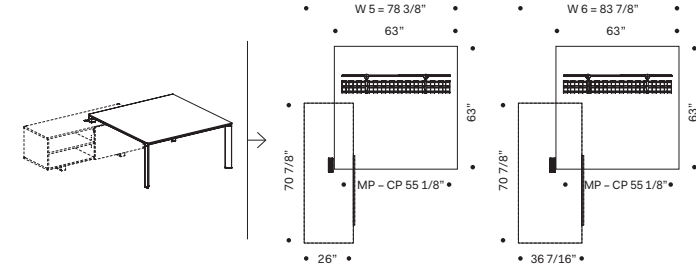

D 63" x H 29 9/16"

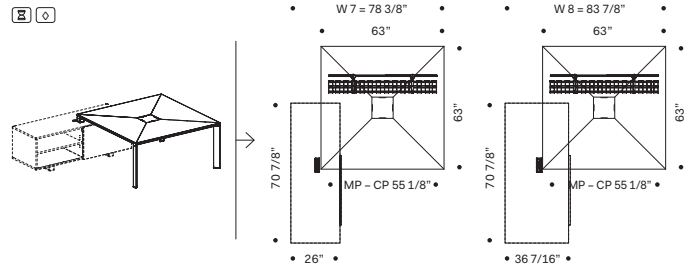

Mobili di servizio e cassetteria interna/Service units and internal pedestals

W 70 7/8" D 26" x H 24 13/16"

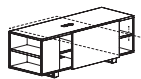

901.MS.6_18_Dx/R - Sx/L
Indipendenti e per integrazione
/Independent and for integration

W 70 7/8" D 36 7/16" x H 24 13/16"

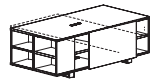

901.MS.9_18_Dx/R - Sx/L
Indipendenti e per integrazione
/Independent and for integration

W 16 1/2" D 21 5/8" x H 18 7/8"



550.CM.01.04

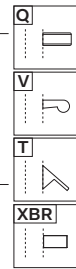

Note: La finitura nero opaco non è in pronta consegna, per la disponibilità contattare l'ufficio commerciale./Matt black finishes is not in prompt delivery. Please contact the commercial department to check availability.

Mobili di servizio /Service units

W 47 1/4" D 23 5/8" x H 24 1/4"



550.CM.S0.12
Su ruote/On castors

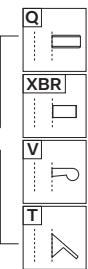

Cassettiere /Pedestals

W 16 1/2" D 22 1/2" x H 21 7/8"



550.CS.10.04
Melaminico/Melamine



550.CS.20.04
Melaminico/Melamine

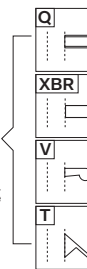

W 12 11/16" D 21 3/8" x H 21 7/8"



550.CS.1M.03
Metalliche/Metallic



550.CS.2M.03
Metalliche/Metallic

W 16 5/8" D 21 3/8" x H 21 7/8"



550.CS.1M.04
Metalliche - Vaschetta porta cancelleria inclusa
/Metallic - Stationery tray included



550.CS.2M.04
Metalliche - Vaschetta porta cancelleria inclusa
/Metallic - Stationery tray included

Accessori /Accessories

W 35 7/16" D 23 5/8" x H 13/16"

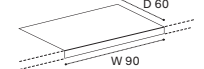

300.AS.01.09

Note: Per portacancelleria cassette, vedi capitolo DV300-Accessori/For stationary tray, see chapter DV300-Accessories.

Modesty panel - Canalizzazione per tavoli scrivanie/Modesty panel - Wire management for desks

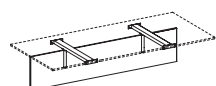

901.MP.01.16_W 55 1/8" (63"x31 1/2")
901.MP.01.18_W 63" (70 7/8"x35 7/16")
901.MP.01.20_W 70 7/8" (78 6/8"x35 7/16")
901.MP.11.16_W 55 1/8" (63"x63") (L 5 - L 6)

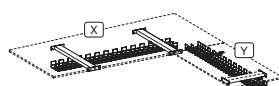

901.AP.15.16_W 55 1/8" (63"x31 1/2") X
901.AP.15.18_W 63" (70 7/8"x35 7/16") X
901.AP.15.20_W 70 7/8" (200x35 7/16") X
901.AP.24.12_W 63" (94 1/2"x47 1/4") X
901.AP.12.06_W 55 1/8" (47 1/4"x23 5/8") Y
901.AP.17.16_W 55 1/8" (63"x63") (L 5 - L 6)
901.AP.18.16_W 55 1/8" (63"x63") (L 7 - L 8) Z

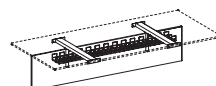

901.MP.06.16_W 55 1/8" (63"x31 1/2")
901.MP.06.18_W 63" (70 7/8"x35 7/16")
901.MP.06.20_W 70 7/8" (78 6/8"x35 7/16")
901.MP.12.16_W 55 1/8" (63"x63") (L 5 - L 6)

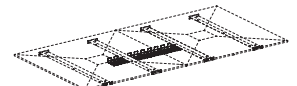

901.AP.32.12_W 43 3/8" Z
Per piani composti L = 320 cm
/For composed tops W = 126"

Modesty panel – Canalizzazione per tavoli scrivanie su mobili di servizio/Modesty panel – wire management for desks on service units

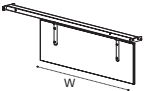
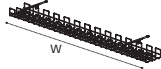
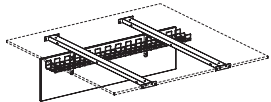
			
901.AP.22.18_ W 55 1/8" (70 7/8"×35 7/16") (W1 – W2) 901.AP.22.20_ W 63" (78 6/8"×35 7/16") (W3 – W4) 901.AP.17.16_ W 55 1/8" (63"×63") (W5 – W6) 901.AP.18.16_ W 55 1/8" (63"×63") (W7 – W8) <input type="checkbox"/>	901.MP.08.12_ W 47 1/4" (W1 – W2) Per tavoli scrivania L 180 /For desks W 70 7/8" 901.MP.11.16_ 55 1/8" (63"×63") (W5 – W6) Per tavoli riunione L 160 /For meeting tables W 63" 901.MP.09.14_ W 55 1/8" (W3 – W4) Per tavoli scrivania L 200/For desks W 78 6/8"	901.AP.21.18_ (W1 – W2) 901.AP.21.20_ (W3 – W4) Da abbinare a modesty panel /To be used with modesty panel	901.MP.12.16_ W 55 1/8" (63"×63") (W5 – W6)



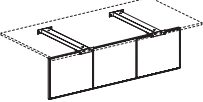
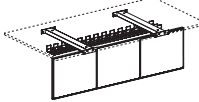

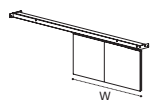
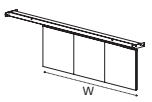
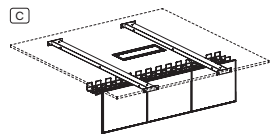

Modesty panel in cuoio per tavoli scrivanie /Leather modesty panel for desks



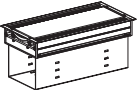

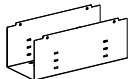
	
901.MP.01.16_ W 55 1/8" (63"×31 1/2") 901.MP.01.18_ W 63" (70 7/8"×35 7/16") 901.MP.01.20_ W 70 7/8" (78 6/8"×35 7/16") 901.MP.11.16_ W 55 1/8" (63"×63") (W5 – W6)	901.MP.06.16_ W 55 1/8" (63"×31 1/2") 901.MP.06.18_ W 63" (70 7/8"×35 7/16") 901.MP.06.20_ W 70 7/8" (78 6/8"×35 7/16") 901.MP.12.16_ W 55 1/8" (63"×63") (W5 – W6)

Modesty panel in cuoio per tavoli scrivanie su mobili di servizio /Leather modesty panel for desks on service units

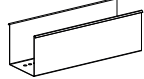
		
901.MP.08.12_ W 47 1/4" (70 7/8"×35 7/16") (W1 – W2)	901.MP.09.14_ W 55 1/8" (78 6/8"×35 7/16") (W3 – W4) 901.MP.11.16_ W 55 1/8" (63"×63") (W5 – W6)	901.MP.12.16_ W 55 1/8" (63"×63") (W5 – W6)

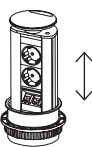
Accessori per canalizzazione – Elettificazione – Vari/Accessories for wire management – Electrification – Various

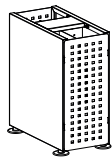
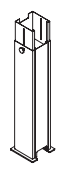
						
300.AC.26.02 W 9 5/8" 300.AC.26.03 W 13 5/8" 300.AC.26.04 W 17 1/2"	300.AC.20.02_ W 9 5/8" 300.AC.20.03_ W 13 5/8" 300.AC.20.04_ W 17 1/2"	300.AC.25.02 W 9 1/4" 300.AC.25.03 W 13 3/16" 300.AC.25.04 W 17 1/8" Marsupio/Basket	300.AP.S1.02 W 8 1/8" 300.AP.S1.03 W 11 7/8" 300.AP.S1.04 W 16 1/2" Per/For top access 300.AC.26_	300.AT.A6.02 L 8 1/4" 300.AT.A6.03 L 10" 300.AT.A6.04 L 15 3/8"	300.AC.38.02_ H 15/16"	300.AC.67.03 Marsupio per top access 300.AC.38.02 /Basket for top access 300.AC.38.02

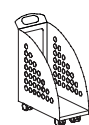
						
300.AP.T4.01 300.AP.T5.01 – UK <input type="checkbox"/> 300.AP.T6.01 – US <input type="checkbox"/>	Ø 3 1/8" 300.AP.T8.11 300.AP.T8.14 300.AP.T8.17 300.AP.T8.20	300.AP.T7.01 Ø 2 3/8" 300.AP.T8.01 Ø 3 1/8"	300.AC.16.02_	300.AP.V2.15	300.AP.V1.00	300.AC.06.05_

Bracci porta video/Arms for video support

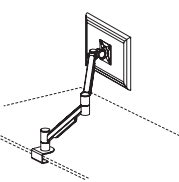
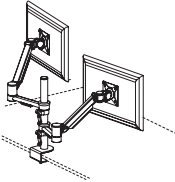
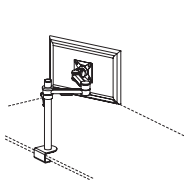
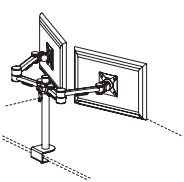
			
300.AC.02.01 Braccio porta video mobile su piano /Dynamic arm for video support on deskbase	300.AC.02.02 Doppio braccio porta video mobile su piano/2 dynamic arms for video support on deskbase	300.AC.01.01 Braccio porta video statico su palo/Static arm for video support on pole	300.AC.01.02 Doppio braccio porta video statico su palo/2 Static arms for video support on pole

Note:

- | | | |
|---|---|---|
| <p>1 Le finiture gres e cuoio non sono in pronta consegna. Per la disponibilità contattare l'ufficio commerciale/ Porcelain stoneware and leather finishes are not in prompt delivery. Please contact the commercial department to check availability;</p> <p>2 Le dimensioni sono espresse in pollici - consultare il listino prezzi per le caratteristiche tecniche, i codici degli articoli e delle finiture/Dimensions are stated in inch - for technical characteristics, article code numbers and finishing see price list;</p> | <p>3 Per la scelta dei contenitori e degli accessori vari, consultare il relativo listino o catalogo/To choose storage units and accessories, please check correspondent price list or catalogue;</p> <p><input type="checkbox"/> Prodotti non in pronta consegna. Per la disponibilità contattare l'ufficio commerciale/Items not in prompt delivery. Please contact the commercial department to check availability;</p> <p><input type="checkbox"/> Articoli prodotti solo su richiesta/Items produced only on demand;</p> | <p><input type="checkbox"/> Con serratura/With lock;</p> <p><input type="checkbox"/> Tavoli scrivania con piani composti/Desks with compound worktops.</p> <p><input type="checkbox"/> Cuoio/Leather;</p> |
|---|---|---|